

- UL Listed
- 3-Step MacAdam's ellipse, single binning
- L70- Over 40,000 hours
- Reverse voltage protection
- Minimum 3oz copper PCB

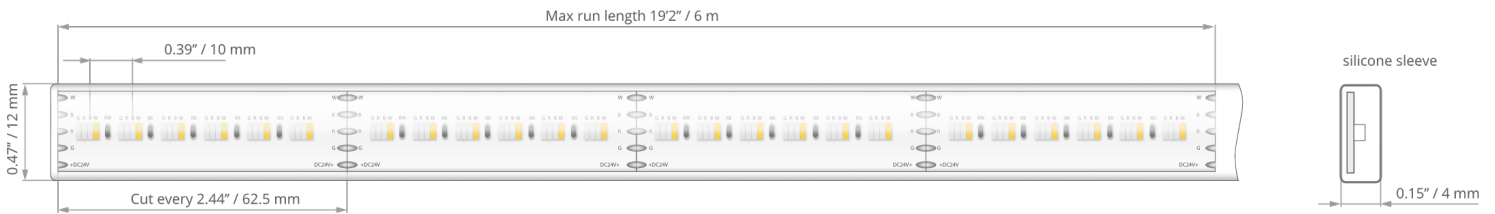

TECHNICAL DATA

Model	IP protection	Power consumption	Color temperature	Lumen output	Diode QTY per foot	Input voltage	Beam Angle	Max run length	LED width
WP-K-1530-RGB+W-24V	IP 65 (silicon sleeve)	4.6 W/ft	3000 K	94 lm/ft	115 pcs/ft	24 V	120 °	19'2"	12 mm
			Blue	123 lm/ft					
			Green						
			Red						

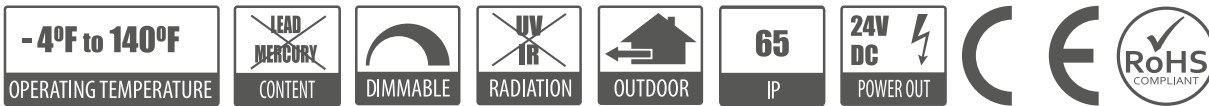

WIRE OPTIONS

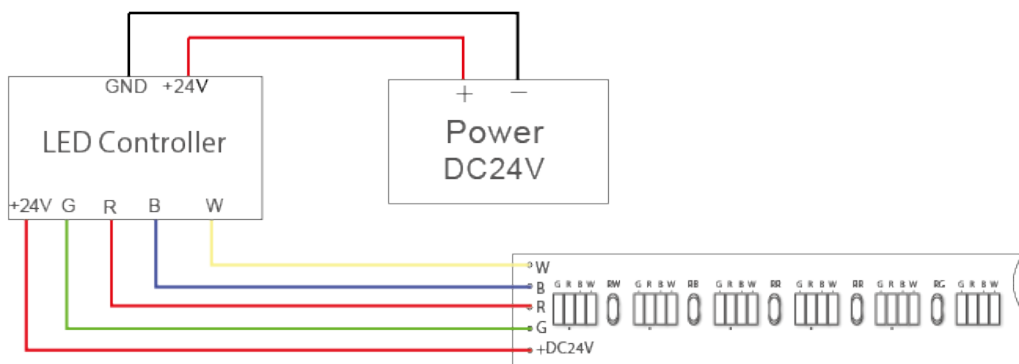

RELATED EXTRUSIONS

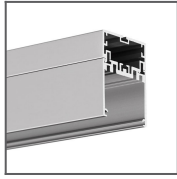

4050 Extrusion
Ref: 18050

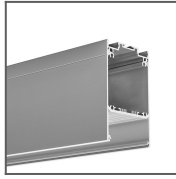

DES Extrusion
Ref: 18030ANODA

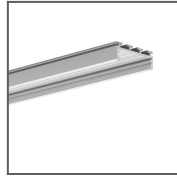

GIZA Extrusion
Ref: B5556ANODA

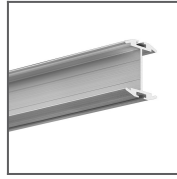

GIZA-DUO-LL
Extrusion
Ref: C2162

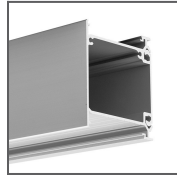

IDOL Extrusion
Ref: 18014ANODA

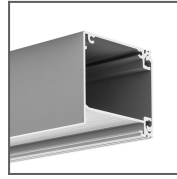

IKON Extrusion
Ref: 18013ANODA

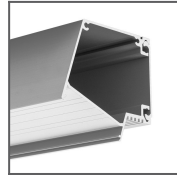

IMET Extrusion
Ref: 18012ANODA

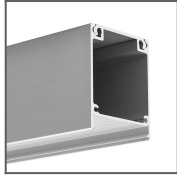

INTER Extrusion
Ref: 18011ANODA

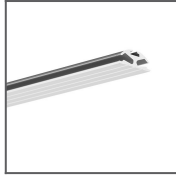

JAZ Extrusion
Ref: B8547ANODA

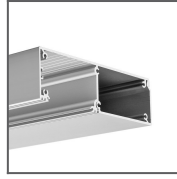

KIDES Extrusion
Ref: 18031ANODA

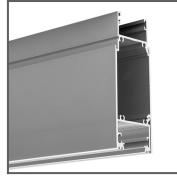

KIDES-DUO
Extrusion
Ref: 18032ANODA

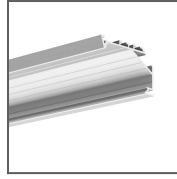

KOPRO-30
Extrusion
Ref: B7890ANODA

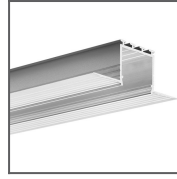

KOZEL Extrusion
Ref: B6454

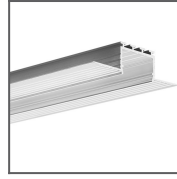

KOZUS Extrusion
Ref: B7823NA

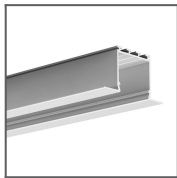

LARKO Extrusion
Ref: B5552ANODA

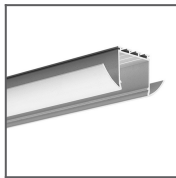

LESTO Extrusion
Ref: B5551ANODA

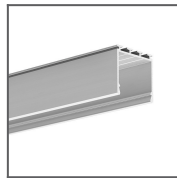

LIPOD Extrusion
Ref: B5554ANODA

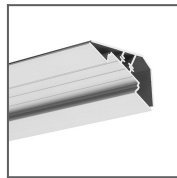

LOC-30 Extrusion
Ref: 18015ANODA

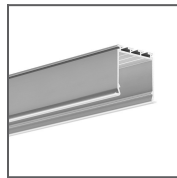

LOKOM Extrusion
Ref: B5553ANODA

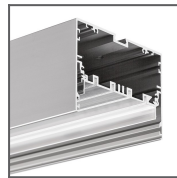

MOD-100
Extrusion
Ref: 18049

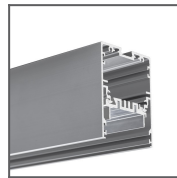

MOD-50
Extrusion
Ref: 18047

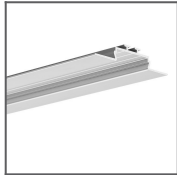

OPAC-30
Extrusion
Ref: B6164ANODA

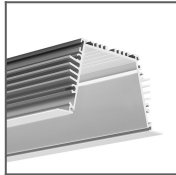

SEKODU
Extrusion
Ref: B6597ANODA

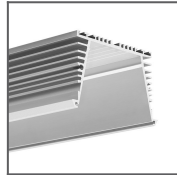

SEKOMA
Extrusion
Ref: B6595ANODA

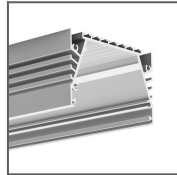

SEPOD Extrusion
Ref: B6593ANODA

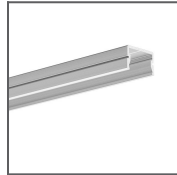

SILER Extrusion
Ref: B9325ANODA

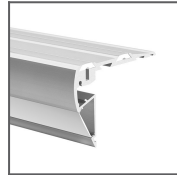

STEPUS
Extrusion
Ref: 18038ANODA