

MOUNTING INSTRUCTIONS

1. First remove cover by unscrewing two bolts holding cover to the can.
2. Remove LED Step Light reflector by unscrewing two bolts holding reflector to top of LED assembly and gently lifting reflector out of can.
3. Remove LED assembly by gently lifting assembly just out of the can.
4. Place all loose parts in a secure location until reassembly.
5. Select a mounting location for the LED Step Light. Fixture should be within reach of 110v power, located approximately 9 inches above the floor in a step light application, and situated at the best location along the mounting surface for the illumination task.
6. Cut a 5-1/2" (L), 4" (W), and 2-1/2" (D) hole in mounting surface for the can.

7. LED Step Light has wide flanges that will allow the can to be securely affixed to almost any surface with the four mounting screws and wall anchors provided. Place can in hole and mark the position of the four for mounting screws. Remove can and drill a pilot hole for the screws, or a hole for the wall anchors. Install anchors (if applicable), reposition can in hole, and securely fasten the can to the mounting surface by firmly tightening four mounting screws.

CAUTION! Local code may require plywood backing with wood screws (not included) for ceiling mount applications. Check with your local building department before installation.

WIRING INSTRUCTIONS

CAUTION! Only qualified electricians, or people familiar with household electrical circuits, should bring 110VAC power to the fixture. Wiring may require an inspection by the local building department. Check with your local building department before installation.

CAUTION! Before bringing 110VAC power to the fixture, make sure incoming wire is not "hot" and all power coming to the wire is off.

CAUTION! All connections must be made in accordance with this instruction manual, current NEC, and all local building codes. Minimum 90°C supply conductors.

CAUTION! When installing in a wet location, use RTV silicone or water-tight fittings on all connections to fixture.

1. Through one of the many knockouts provided, bring in 110V power wiring. If 110VAC wire will not conveniently enter one of the four knock-outs provided, simply unscrew the can, rotate can 180 degrees and reinstall. Can is entirely symmetrical, and 180 degree rotation will not affect mounting holes.
2. Secure wire to fixture with the appropriate strain relief (not provided).
3. Strip 1/3" (8mm) of the insulation off each incoming 110V power wire. Connect white incoming 110VAC wire (neutral wire) to push-in connector on white wire from LED driver. Connect black incoming 110VAC wire to push-in connector on black wire from LED driver. Connect ground wire to push-in connector on green wire screwed into can. Push all wires firmly down into connectors, so that uninsulated wire is not exposed.
4. Reinstall assembly, reflector and cover.

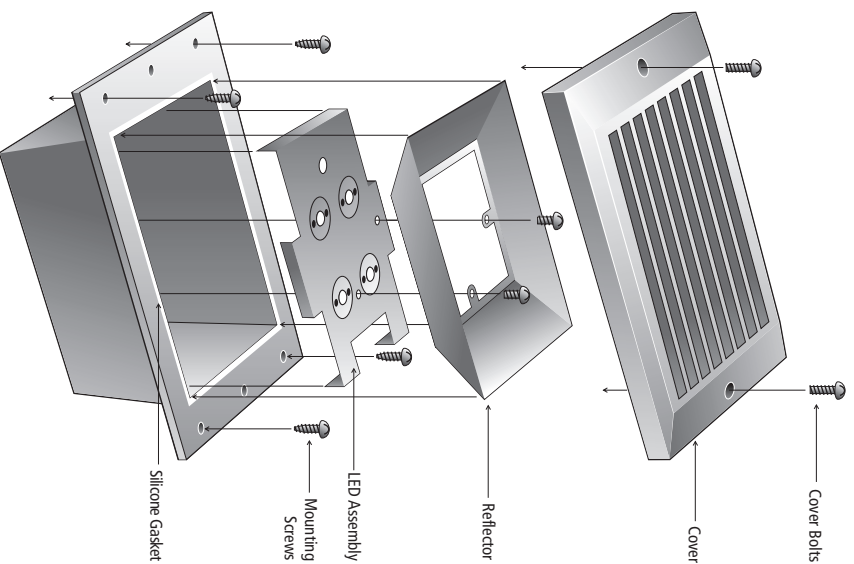

REPLACEMENT OF LED ASSEMBLY

Field replacement of the LED assembly is not allowed by UL standards at this time. If you encounter a problem with the LED assembly:

1. Turn off all power to the LED Step Light.
2. With test lamp verify power is coming through the LED Step Light fixture circuit.
3. Verify 110VAC wiring and connections: black wire to black LED wire push-in connector, white power wire to white LED wire push-in connector, and green ground wire to green wire push-in connector. Make sure all conductors have 1/3" of insulation stripped of and are fully seated into push-in connector.
4. Verify connections with red wire from LED driver to red wire from LED assembly, and black wire from LED driver to black wire from LED assembly

If above have been proven correct, turn off power to the fixture, remove fixture from mounting surface, cut incoming power wire, return fixture to place of purchase for replacement.

WARNING! If this fixture is to be placed in a masonry or brick wall, you must use a Concrete Cap during installation to provide the proper void for the fixture cover. Failure to use the Concrete Cap will almost guarantee concrete or grout forming against fixture can flange, and poor cover-to-can seal (see below). Poor cover seal will allow water/moisture into fixture resulting in LED and Xenon failure.

Without Concrete Cap

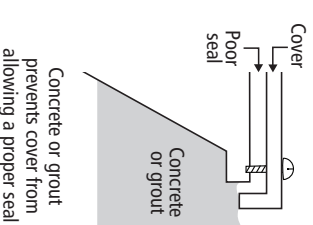

With Concrete Cap

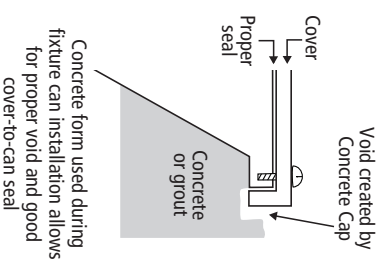

THROUGH-WIRE, 110V POWER

- Disconnect from all 110V power prior to installation.
- Connections must be made in accordance with all local electric codes and/or NEC.
- Minimum 90°C supply conductors.
- Interconnect up to 120 fixtures per 110VAC tap.
- 14 gauge (Romex Type) or better wire is required.
- Requires strain reliefs.
- Installations in wet locations should use RTV silicone or water-tight fittings on all connections to fixtures.

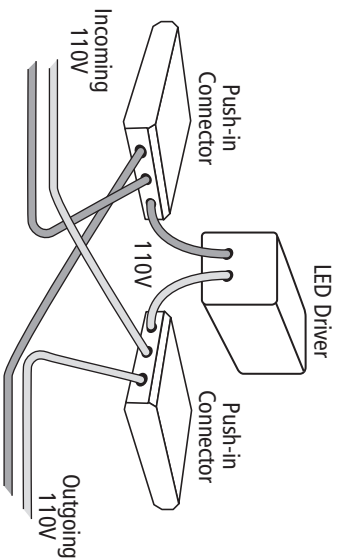
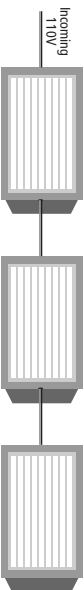

OTHER LED PRODUCTS BY NSL

LED BRICK LIGHT

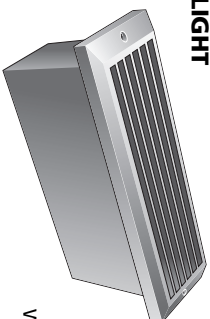

cUL
us
Wet and IC Locations

Long lasting LED technology in a brick-sized die cast aluminum fixture.

LED MINIDISC LIGHT

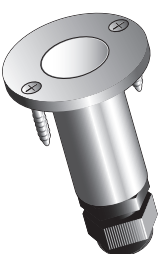

cUL
us
Wet, IC and Direct
Burial Locations

The perfect mini light for outlining and illuminating architectural features.

LED REFLECTIVE LIGHT



cUL
us
Wet and IC Locations

Medium size wall-mounted fixture that reflects the brightness of 22 LEDs.

MICRO LED LIGHT STRIP



cUL
us
Wet Location

Embedded LED/chip technology extruded in a flexible light strip.

INSTALLATION INSTRUCTIONS

LED STEP LIGHT

LED Technology in a die cast
aluminum Step Light Fixture

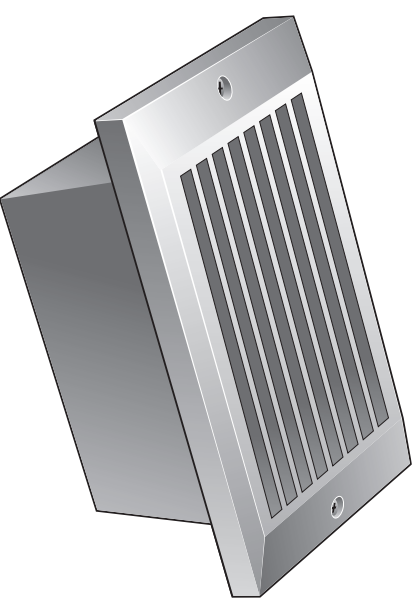

- 60,000-hour LED life

- Ultra low 6.5 watts per fixture

- Louver, Scoop & Prism cover designs

- White, Bronze, Black and Aluminum colors

- Die cast aluminum design suitable for concrete pour, framed walls, ceilings & showers

- UL Listed for wet and IC locations

NSL
NATIONAL SPECIALTY LIGHTING

cUL
us
LISTED
Wet and IC Locations

NATIONAL SPECIALTY LIGHTING
ARCHITECTURAL AND DECORATIVE LIGHTING

LOUISVILLE, CO 80027

www.nslusa.com

© 2007 National Specialty Lighting

9/08